

**PHILIPS**

*Service*

RADIO

**L3F42 T/00L/00R/00S**

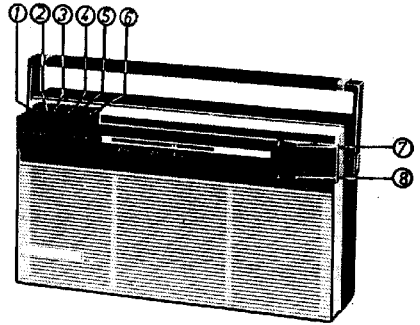

TRA 2159



- |                                                                                                                                                                                                                                                              |                                                                                                                                                                                                                                                                                                       |                                                                                                                                                                                                                                                                                                                                                                                              |
|--------------------------------------------------------------------------------------------------------------------------------------------------------------------------------------------------------------------------------------------------------------|-------------------------------------------------------------------------------------------------------------------------------------------------------------------------------------------------------------------------------------------------------------------------------------------------------|----------------------------------------------------------------------------------------------------------------------------------------------------------------------------------------------------------------------------------------------------------------------------------------------------------------------------------------------------------------------------------------------|
| <p><b>1</b> Switch (on)<br/>Schakelaar (aan)<br/>Commutateur (marche) SK-C<br/>Schalter (ein)<br/>Commutador (conectado)</p> <p><b>2</b> Switch (off)<br/>Schakelaar (uit)<br/>Commutateur (arrêt) SK-C<br/>Schalter (aus)<br/>Commutador (desconectado)</p> | <p><b>3</b> MW switch<br/>MG-schakelaar<br/>Commutateur PO SK-B<br/>MW-Schalter<br/>Commutador OM</p> <p><b>4</b> LW switch<br/>LG-schakelaar<br/>Commutateur GO SK-B<br/>LW-Schalter<br/>Commutador OL</p> <p><b>7</b> Tuning<br/>Afstemming<br/>Sintonisation<br/>Abstimmung<br/>Sintonía C1-C2</p> | <p><b>5</b> Aerial switch<br/>Antenneschakelaar<br/>Comm. d'antenne SK-A<br/>Antennenschalter<br/>Comm. de antena</p> <p><b>6</b> Ferroceptor switch<br/>Ferroceptor-schakelaar<br/>Comm. de ferroceptor SK-A<br/>Ferroceptor-Schalter<br/>Comm. de ferroceptor</p> <p><b>8</b> Volume control<br/>Volumeregelaar<br/>Contrôle de volume R30<br/>Lautstärkereglér<br/>Control de volumen</p> |
|--------------------------------------------------------------------------------------------------------------------------------------------------------------------------------------------------------------------------------------------------------------|-------------------------------------------------------------------------------------------------------------------------------------------------------------------------------------------------------------------------------------------------------------------------------------------------------|----------------------------------------------------------------------------------------------------------------------------------------------------------------------------------------------------------------------------------------------------------------------------------------------------------------------------------------------------------------------------------------------|

<p>Loudspeaker IF 311118 50330(25 Ω) 455 kc/s Battery 9 V (2x4, 5 V) +1, 5V Consumption 12 mA (without signal) Output 250 mW Dimensions 265x72x155 mm</p>	<p>Luidspreker MF Batterij Verbruik (zonder signal) Uitgangsvermogen Afmetingen</p>	<p>Haut-parleur FI Batterie Consommation (sans signal) Puissance de sortie Dimensions</p>	<p>Lautsprecher ZF 3111 118 50330(25 Ω) 455 kc/s Batterie 9 V (2x4, 5 V)+1, 5V Verbrauch 12 mA (ohne Signal) Ausgangsleistung 250 mW Abmessungen 265x72x155 mm</p>	<p>Altavoz FI Batería Consumo (sin señal) Potencia de salida Dimensiones</p>
---------------------------------------------------------------------------------------------------------------------------------------------------------------------------------------	---------------------------------------------------------------------------------------------------------	---------------------------------------------------------------------------------------------------------------	------------------------------------------------------------------------------------------------------------------------------------------------------------------------------------------------	--------------------------------------------------------------------------------------------------

**WAVE RANGES - GOLFGEBIEDEN - GAMMES D'ONDES - WELLENBEREICHE - MARGENES DE ONDAS**

MW - MG - PO - MW - OM	:	187 - 572 m (1635 - 617 kc/s)
LW - LG - GO - LW - OL	:	1150 - 1950 m ( 250 - 150 kc/s)

**TRANSISTORS**

TS1 : AF127	TS4 : AC132
TS2 : AF127	TS5 : AC132
TS3 : AC125	

**DIODE**

GRI : OA79

SERVICE INFORMATION									
---------------------	--	--	--	--	--	--	--	--	--

JZ/CID

Copyright Central Service N.V. PHILIPS' GLOEILAMPENFABRIEKEN, Eindhoven  
Confidential information for Philips Service Dealers

93 755 25.1.90

Printed in Holland

L3F42T

Serv-o-mecum	Push button Druktoets Touche Taste Tecla	Variable capacitor Variabele condensator Condensateur variable Drehkondensator Condensador variable	Signal Signaal Signal Signal Señal	Adjust to max. output Afregelen op max. uitgangsvermogen Régler sur puissance maximale Abgleichen auf max. Ausgangleistung Ajustar a la potencia máx. de salida
E-a-1 E-a-2				
IF MF FI ZF FI	MW - ferroceptor MG - ferroceptor PO - ferrocepteur MW - Ferroceptor OM - ferroceptor	Min.	455 kc/s ④	① S17-18-19 ① S13-14 S15-16
RF	MW - antenne MG - antenne PO - antenne MW - Antenne OM - antena	Max. Min.	517 kc/s ② 1835 kc/s ②	S10-11-12 S5-6 C3-C4
	Repeat - Herhalen - Répéter - Wiederholen - Reptanse			
	HF HF HF RF	LW - antenne LG - antenne GO - antenne LW - Antenne OL - antena	③	160 kc/s ②
	LW - ferroceptor LG - ferroceptor GO - ferrocepteur LW - Ferroceptor OL - ferroceptor	③	240 kc/s ④	C8

- Damp S16 by means of a resistor of 10 Ω in series with a capacitor of 100 kP, connected between BTS2 and mass (+).  
S16 dempen d.m.v. weerstand van 10 Ω in serie met condensator van 100 kP, geschakeld tussen BTS2 en massa (+).  
Amortir S16 au moyen d'une résistance de 10 Ω en série avec un condensateur de 100 kP connecté entre BTS2 et la masse (+).  
S16 mit einem Widerstand von 10 Ω in Reihe mit einem Kondensator von 100 kP, der zwischen BTS2 und Masse (+) angeordnet ist, dämpfen.  
Amortiguar S16 con una resistencia de 10 Ω en serie con un condensador de 100 kP, conectado entre BTS2 y masa (+).
- Via a capacitor of 15 pF supply the signal to junction C11-aerial connection. Connect a capacitor of 70 pF (parasitic capacitance of a car aerial) across C11.  
Het signaal via condensator van 15 pF toevoeren aan knooppunt C11-antenne-aansluiting. Over C11 een condensator van 70 pF aansluiten (parasitaire capaciteit van een auto-antenne).  
Appliquer le signal par l'intermédiaire d'un condensateur de 15 pF au noeud C11-antenne-connexion. Raccorder au condensateur de 70 pF à travers C11 (capacité parasitaire d'une antenne-auto).  
Das Signal über einem Kondensator von 15 pF den Knotenpunkt C11-Antennenschluss-zuführen. Über C11 einen Kondensator von 70 pF anschliessen. (Parasitäre Kapazität einer Autoantenne.)  
Aplicar la señal a través de un condensador de 15 pF al punto de unión C11 - conexión de antena. Conectar un condensador de 70 pF en bornes de C11 (capacidad parásita de una antena de auto).

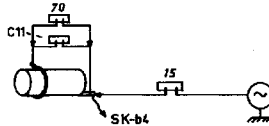

- Tune the apparatus.  
Apparaat afstemmen.  
Synchroniser l'appareil.  
Gerät abstimmen.  
Sintonizar el aparato.
- Supply signal via a coupler winding round ferroceptor.  
Signaal toevoeren via een koppelwinding om ferroceptor.  
Appliquer un signal par l'intermédiaire d'un enroulement d'accouplement autour du ferroceptor.  
Signal über eine Koppelwinding um Ferroceptor zuführen.  
Aplicar una señal a través de una espira de acoplamiento alrededor del ferroceptor.

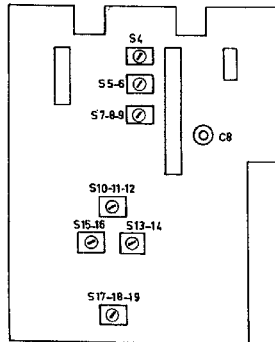
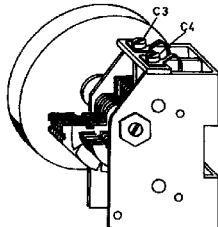
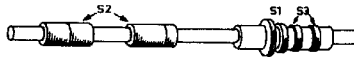

S	E.G.O.C.B.A.F.										
F	11	21	26	18, 20, 12, 19, 7, 25	22, 5, 13, 6, 8, 23, 19, 12						
R	30	1, 21	7	5, 6	9, 4	11, 3	10	2			

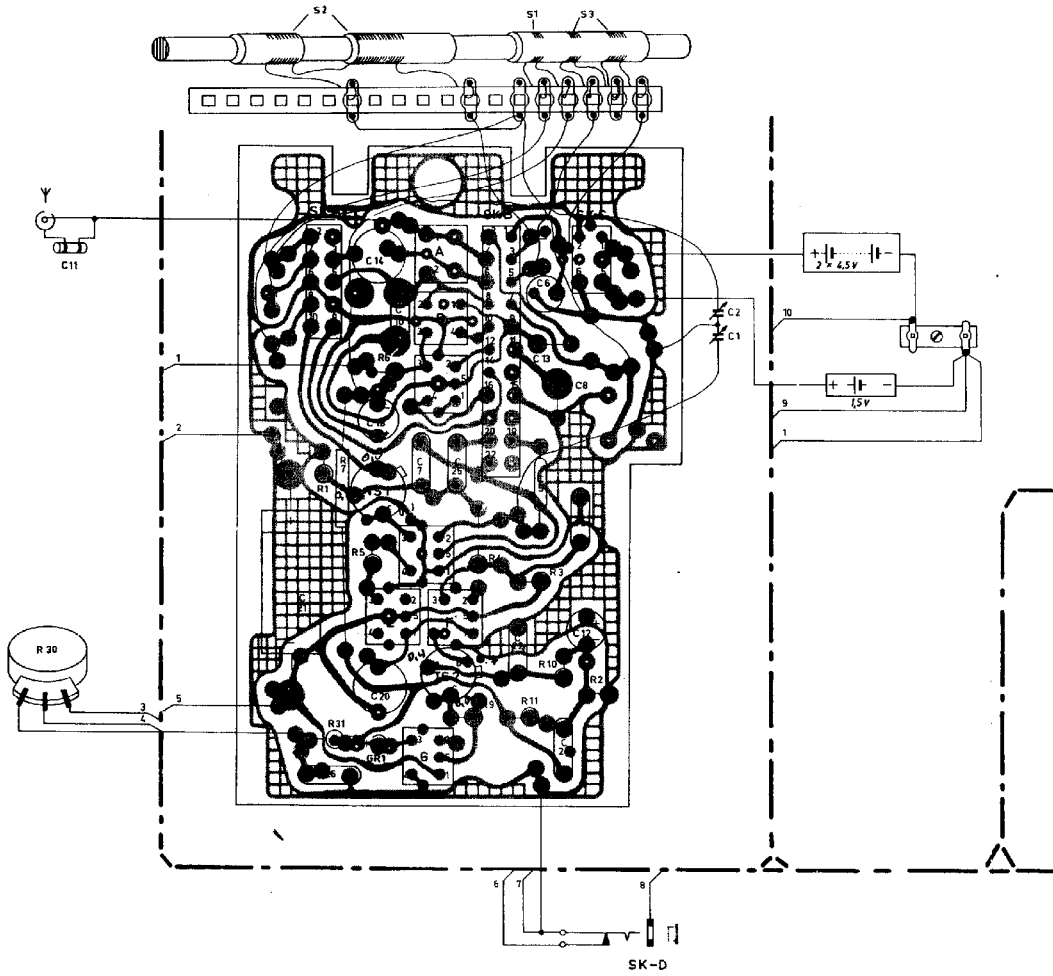



S			4	6	8	9	5	7		2	3	1			11	12	10
C	14	13	10	11	3	1		8		6		2	5	4	7	25	24
R																	

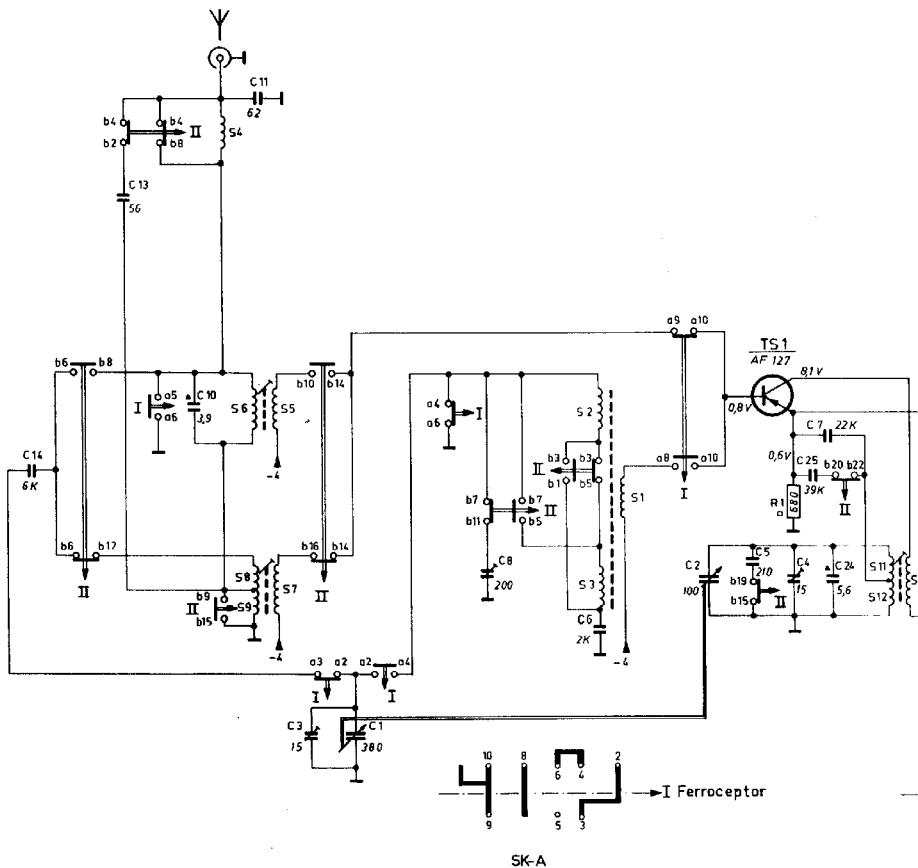

THE MENTIONED VOLTAGES HAVE BEEN MEASURED WITH RESPECT TO +, WITH AN ELECTRONIC VOLTMETER.

DE AANGEGEVEN SPANNINGEN ZIJN GEMETEN TEN OPZICHTE VAN +, MET EEN BUISVOLTMETER.

LES TENSIONS INDIQUEES ONT ETE MESUREES PAR RAPPORT A +, AVEC UN VOLTMETRE ELECTRONIQUE.

DIE ANGEGBENEN SPANNUNGEN SIND IN BEZUG AUF +, MIT EINEM RÖHRENVOLTMESSE GEMESSEN.

LAS TENSIONES INDICADAS FUERON MEDIDAS CON RESPECTO A +, CON UN VOLTIMETRO ELECTRONICO.

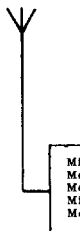

# L3F42T

11	12	10	13	14	15	16	17	18	19	20	21	22	18	26	30	31	33	36	37	6	41	34	35	32	33	25	26	23	24	27	
5																															

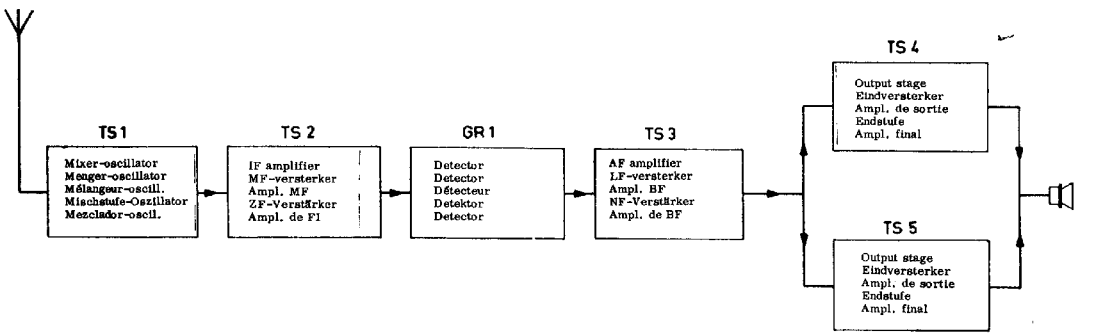
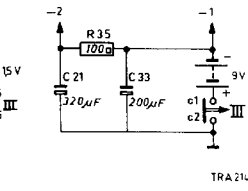
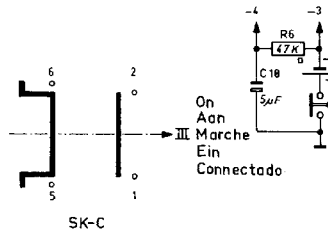
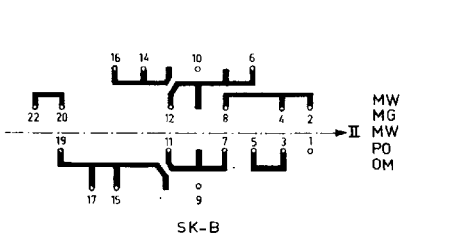
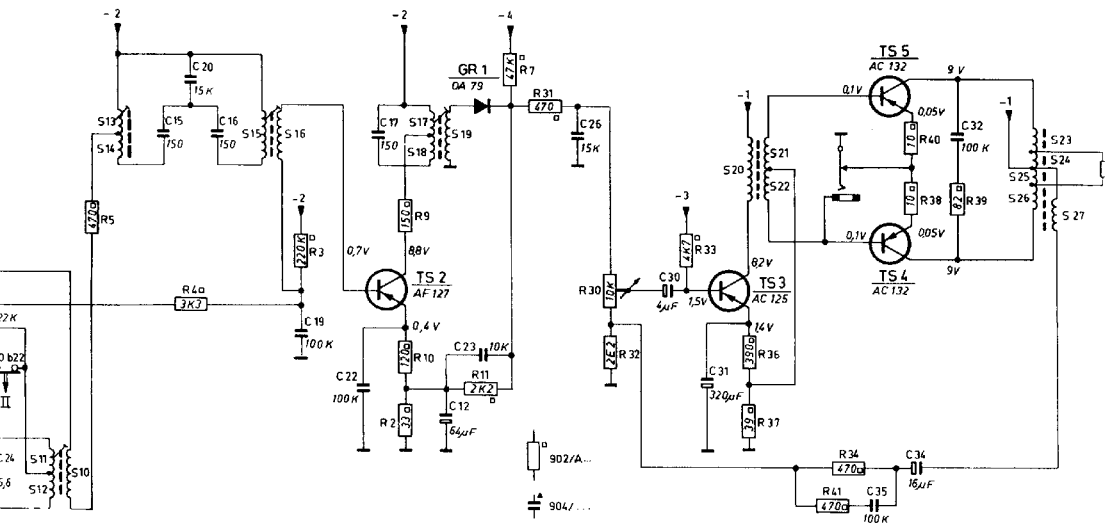

S	F, A, B, C, D, G, E									
C	12, 19, 23, 8, 6, 13, 5, 22,	25,	7,	10, 14, 20, 18,	26,	21,				
R	2,	10,	3, 11,	4, 9,	6, 5,	7, 31, 1,				

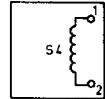
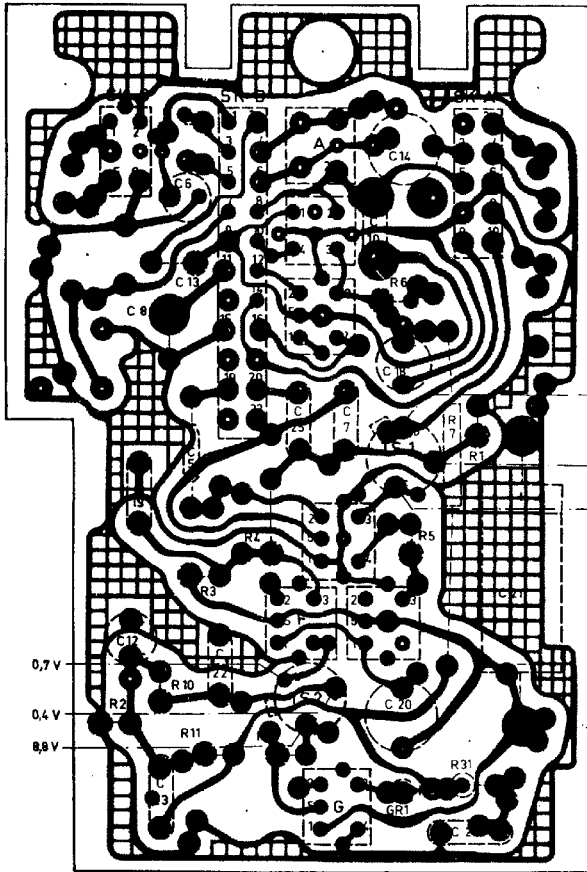

A

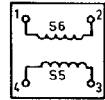

B

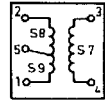

C

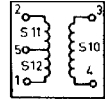

D

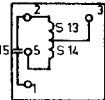

E

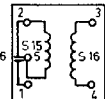

F

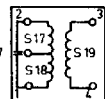

G

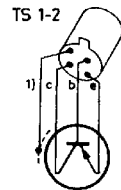





Cabinet (version -/00L, -/00R)	4822 420 40112	Kast (-/00L, -/00R-uitvoering)	4822 420 40112	Coffret (version -/00L, -/00R) Das Gehäuse (-/00L, -/00R-Ausführung)	4822 420 40112	Caja (versión -/00L, -/00R)
Cabinet (version -/00S)	4822 420 40111	Kast (-/00S-uitvoering)	4822 420 40111	Coffret (version -/00S)	4822 420 40111	Caja (versión -/00S)
Rear panel (version -/00L)	4822 421 40012	Achterwand (-/00L-uitvoering)	4822 421 40012	Coffret (version -/00L)	4822 421 40012	Panel posterior (versión -/00L)
Rear panel (version -/00R)	4822 421 40011	Achterwand (-/00R-uitvoering)	4822 421 40011	Coffret (version -/00R)	4822 421 40011	Panel posterior (versión -/00R)
Rear panel (version -/00S)	4822 421 40013	Achterwand (-/00S-uitvoering)	4822 421 40013	Coffret (version -/00S)	4822 421 40013	Panel posterior (versión -/00S)
Screw to secure rear panel	4822 502 10634	Schroef voor bev. achterwand	4822 502 10634	Vis fix. paroi arrière	4822 502 10634	Tornillo para fij. panel posterior
Grip	4822 498 40187	Handgreep	4822 498 40187	Poignée	4822 498 40187	Asa
Screw to secure grip	4822 179 01025	Schroef voor bev. handgreep	4822 179 01025	Vis fix. poignée	4822 179 01025	Tornillo para fij. asa
Battery holder in rear panel	4822 256 60119	Batterijhouder in achterwand	4822 256 60119	Porte-pile dans paroi arrière	4822 256 60119	Soporte de batería en panel posterior
Battery holder in cabinet	4822 179 01027	Batterijhouder in kast	4822 179 01027	Porte-pile dans coffret	4822 179 01027	Soporte de batería en caja
Aerial connection	4822 179 01056	Antenne-aansluiting	4822 179 01056	Connexion d'antenne	4822 179 01056	Conexión de antena
Earphone connection	4822 211 00965	Oortelefoonaansluiting	4822 211 00965	Connexion casque d'écoute	4822 211 00965	Conexión de auricular
Nut to secure earphone connection	A3 715 60	Moer bev. oortelefoonaansluiting	A3 715 60	Ecrou fix. connexion casque	A3 715 60	Tuerca para fij. conexión de auricular
Drum on variable capacitor	FK 340 18	Trommel op var. cond.	FK 340 18	Tambour sur cond. var.	FK 340 18	Tambor sobre cond. var.
Printer	4822 450 50125	Wijzer	4822 450 50125	Aliguille	4822 450 50125	Aguja
Dial (version -/00L)	4822 334 50045	Schaal (-/00L-uitvoering)	4822 334 50045	Cadrán (version -/00L)	4822 334 50045	Cuadrante (versión -/00L)
Dial (version -/00R, -/00S)	4822 334 50046	Schaal (-/00R, -/00S-uitvoering)	4822 334 50046	Cadrán (version -/00R, -/00S)	4822 334 50046	Cuadrante (versión -/00R, -/00S)
Push button unit (on-off)	4822 276 20064	Druktoetsenheid (aan-uit)	4822 276 20064	Bloc à touches (marche-arrêt)	4822 276 20064	Unidad de tecla (interruptor)
Push button (black)	4822 410 20427	Druktoets (rood)	4822 410 20426	Touche (rouge)	4822 410 20426	Tecla (rojo)
Push button (red)	4822 410 20426	Druktoets (zwart)	4822 410 20427	Touche (noire)	4822 410 20427	Tecla (negro)
Slide switch (on-off)	4822 277 30296	Schuifschakelaar (aan-uit)	4822 277 30296	Comm. coulissant (PO-GO)	4822 277 30296	Comm. de corredera (OM-OL)
Slide switch (on-off)	4822 277 30336	Schuifschakelaar (aan-uit)	4822 277 30336	Comm. coulissant (marche-arrêt)	4822 277 30336	Comm. de corredera (OM-OL)
Slide of switch (on-off)	4822 278 20214	Schuit van schakelaar (aan-uit)	4822 278 20214	Tiroir du comm. (marche-arrêt)	4822 278 20214	Corredera para interruptor
Push button unit (aerial MW-LW)	4822 276 20064	Druktoetsenheid (antenne, MG-LG)	4822 276 20064	Bloc à touches (antenne, PO-GO)	4822 276 20064	Unidad de tecla (antena OM-OL)
Push button (black)	4822 410 20427	Druktoets (zwart)	4822 410 20427	Touche (noire)	4822 410 20427	Tecla (negro)
Slide switch (MW-LW)	4822 277 30296	Schuifschakelaar (MG-LG)	4822 277 30296	Comm. coulissant (PO-GO)	4822 277 30296	Comm. de corredera (OM-OL)
Slide of switch (MW-LW)	4822 278 20215	Schuit van schakelaar (MG-LG)	4822 278 20215	Tiroir du comm. (PO-GO)	4822 278 20215	Corredera para comm. (OM-OL)
Slide switch (aerial)	4822 277 30297	Schuifschakelaar (antenne)	4822 277 30297	Comm. coulissant (antenne)	4822 277 30297	Comm. de corredera (antena)
Slide of switch (aerial)	4822 278 20216	Schuit van schakelaar (antenne)	4822 278 20216	Tiroir du comm. (antenne)	4822 278 20216	Corredera para conmutador
Knob (tuning)	4822 413 10041	Knop-(af)stemming	4822 413 10041	Bouton-sélection	4822 413 10041	Botón-sintonización
Knob (volume)	4822 413 50498	Knop-volume	4822 413 50498	Bouton-volume	4822 413 50498	Botón-volumen

# PHILIPS

# Service

## RADIO

## L3F42T/00L/00R/00S

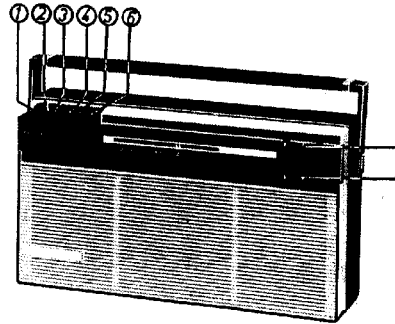

TRA 2159



- |                                                                                                                                                                                                                                                              |                                                                                                                                                                                                                                                                                                       |                                                                                                                                                                                                                                                                                                                                                                                               |
|--------------------------------------------------------------------------------------------------------------------------------------------------------------------------------------------------------------------------------------------------------------|-------------------------------------------------------------------------------------------------------------------------------------------------------------------------------------------------------------------------------------------------------------------------------------------------------|-----------------------------------------------------------------------------------------------------------------------------------------------------------------------------------------------------------------------------------------------------------------------------------------------------------------------------------------------------------------------------------------------|
| <p><b>1</b> Switch (on)<br/>Schakelaar (aan)<br/>Commutateur (marche) SK-C<br/>Schalter (ein)<br/>Commutador (conectado)</p> <p><b>2</b> Switch (off)<br/>Schakelaar (uit)<br/>Commutateur (arrêt) SK-C<br/>Schalter (aus)<br/>Commutador (desconectado)</p> | <p><b>3</b> MW switch<br/>MG-schakelaar<br/>Commutateur PO SK-B<br/>MW-Schalter<br/>Commutador OM</p> <p><b>4</b> LW switch<br/>LG-schakelaar<br/>Commutateur GO SK-B<br/>LW-Schalter<br/>Commutador OL</p> <p><b>7</b> Tuning<br/>Afstemming<br/>Syntonisation C1-C2<br/>Abstimmung<br/>Sintonía</p> | <p><b>5</b> Aerial switch<br/>Antenneschakelaar<br/>Comm. d'antenne SK-A<br/>Antennenschalter<br/>Comm. de antena</p> <p><b>6</b> Ferroceptor switch<br/>Ferroceptor-schakelaar<br/>Comm. de ferrocepteur SK-A<br/>Ferroceptor-Schalter<br/>Comm. de ferroceptor</p> <p><b>8</b> Volume control<br/>Volumeregelaar<br/>Contrôle de volume R3D<br/>Lautstärkereglér<br/>Control de volumen</p> |
|--------------------------------------------------------------------------------------------------------------------------------------------------------------------------------------------------------------------------------------------------------------|-------------------------------------------------------------------------------------------------------------------------------------------------------------------------------------------------------------------------------------------------------------------------------------------------------|-----------------------------------------------------------------------------------------------------------------------------------------------------------------------------------------------------------------------------------------------------------------------------------------------------------------------------------------------------------------------------------------------|

Loudspeaker IF Battery Consumption (without signal) Output Dimensions	3111118 50330(25 Ω) 455 kc/s 9 V (2x4, 5 V) +1,5V 12 mA 250 mW 265x72x155 mm	Luidspreker MF Batterij Verbruik (zonder der signaal) Uitgangsvermogen Afmetingen	Haut-parleur FI Batterie Consommation (sans signal) Puissance de sortie Dimensions	Lautsprecher ZF Batterie Verbrauch (ohne Signal) Ausgangs- leistung Abmessungen	3111 118 50330(25 Ω) 455 kc/s 9 V (2x4, 5 V)+1,5V 12 mA 250 mW 265x72x155 mm	Altavoz FI Batería Consumo (sin señal) Potencia de salida Dimensiones
-----------------------------------------------------------------------------------------	---------------------------------------------------------------------------------------------	-----------------------------------------------------------------------------------------------------	---------------------------------------------------------------------------------------------------------	------------------------------------------------------------------------------------------------------	---------------------------------------------------------------------------------------------	--------------------------------------------------------------------------------------------

### WAVE RANGES - GOLFGEBIEDEN - GAMMES D'ONDES - WELLENBEREICHE - MARGENES DE ONDAS

MW - MG - PO - MW - OM	:	187 - 572 m (1635 - 517 kc/s)
LW - LG - GO - LW - OL	:	1150 - 1950 m ( 250 - 150 kc/s)

### TRANSISTORS

TS1 : AF127	TS4 : AC132
TS2 : AF127	TS5 : AC132
TS3 : AC125	

### DIODE

GR1 : OA79

SERVICE INFORMATION									
---------------------	--	--	--	--	--	--	--	--	--

JZ/CD

Copyright Central Service N.V. PHILIPS' GLOEILAMPENFABRIEKEN, Eindhoven  
Confidential information for Philips Service Dealers

93 755 25.1.90

Printed in Holland



L3F42T

Serv-o-mecum	Push button Druktoets Touche Taste Tecla	Variable capacitor Variabele condensator Condensateur variable Drehkondensator Condensador variable	Signal Signaal Signal Signal Señal	Adjust to max. output Afregelen op max. uitgangvermogen Régler sur puissance maximale Abgleichen auf max. Ausgangsleistung Ajustar a la potencia máx. de salida
E-a-1 E-a-2				
IF MF FI ZF FI	MW - ferroceptor MG - ferroceptor PO - ferroceptor MW - Ferroceptor OM - ferroceptor	Min.	455 kc/s ④	① S17-18-19 ① S13-14 S15-16
RF	MW - antenne MG - antenne PO - antenne MW - Antenne OM - antena	Max. Min.	517 kc/s ② 1635 kc/s ②	S10-11-12 S5-6 C3-C4
	Repeat - Herhalen - Répéter - Wiederholen - Repfianse			
HF	LW - antenne LG - antenne GO - antenne	③	160 kc/s ②	S7-8-9
RF	LW - ferroceptor LG - ferroceptor GO - ferroceptor LW - Ferroceptor OL - ferroceptor	③	240 kc/s ④	C8

- ① Damp S16 by means of a resistor of 10 Ω in series with a capacitor of 100 kpF, connected between bT52 and mass (+).  
S16 dempen d. m. v. weerstand van 10 Ω in serie met condensator van 100 kpF, geschakeld tussen bT52 en massa (+).  
Amortir S16 au moyen d'une résistance de 10 Ω en série avec un condensateur de 100 kpF connecté entre bT52 et la masse (+).  
S16 mit einem Widerstand von 10 Ω im Reihe mit einem Kondensator von 100 kpF, der zwischen bT52 und Masse (+) angeordnet ist, dämpfen.  
Amortiguar S16 con una resistencia de 10 Ω en serie con un condensador de 100 kpF, conectado entre bT52 y masa (+).
- ② Via a capacitor of 15 pF supply the signal to junction C11-serial connection. Connect a capacitor of 70 pF (parasitic capacitance of a car aerial) across C11.  
Het signaal via condensator van 15 pF toevoeren aan knooppunt C11-antenne-aansluiting. Over C11 een condensator van 70 pF aansluiten (parasitaire capaciteit van een auto-antenne).  
Appliquer le signal par l'intermédiaire d'un condensateur de 15 pF au noeud C11-antenne-connexion. Raccorder au condensateur de 70 pF à travers C11 (capacité parasitaire d'une antenne-auto).  
Das Signal über einen Kondensator von 15 pF den Knotenpunkt C11-Antennenschluss-zuführen. Über C11 einen Kondensator von 70 pF anschließen. (Parasitäre Kapazität einer Autoantenne.)  
Aplicar la señal a través de un condensador de 15 pF al punto de unión C11 - conexión de antena. Conectar un condensador de 70 pF en bornas de C11 (capacidad parásita de una antena de auto).

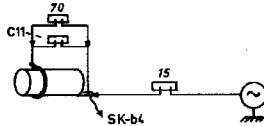

- ③ Tune the apparatus.  
Apparaat afstemmen.  
Synchroniser l'appareil.  
Gerät abstimmen.  
Sintonizar el aparato.
- ④ Supply signal via a coupler winding round ferroceptor.  
Signaal toevoeren via een koppelwinding om ferroceptor.  
Appliquer un signal par l'intermédiaire d'un enroulement d'accouplement autour du ferrocepteur.  
Signal über eine Koppelwinding um Ferroceptor zuführen.  
Aplicar una señal a través de una espira de acoplamiento alrededor del ferroceptor.

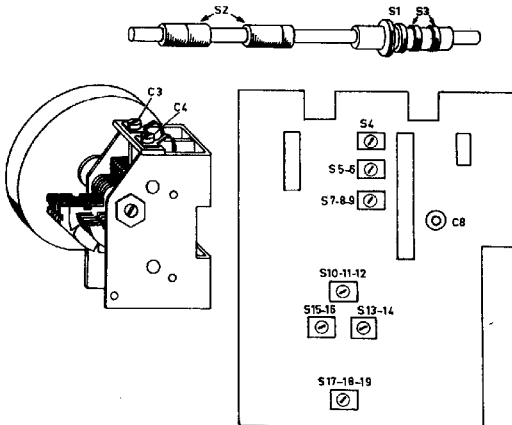

31	30	33	35	32	34
33	35, 32, 36, 37, 41		38	40, 39, 34	

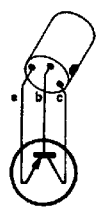
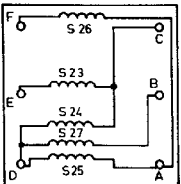
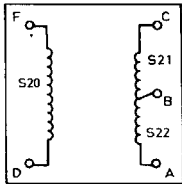
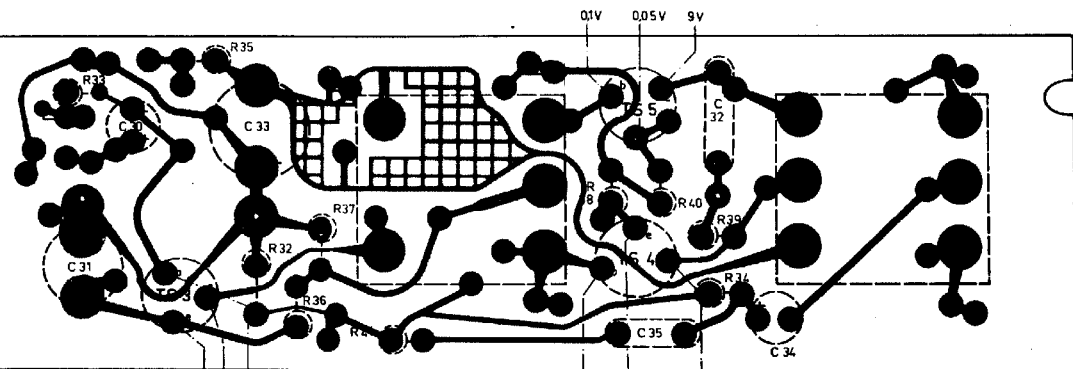

TS 3-4-5

TRA 2161

S	F, A,B,C, D,G, E									
C	12, 18, 23, 8, 6, 13, 5, 22	25, 7, 10, 14, 20, 18,	26, 21,							
R	2, 10, 3, 11, 4, 9,	6, 5, 7, 31, 1, 5								

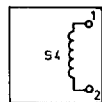
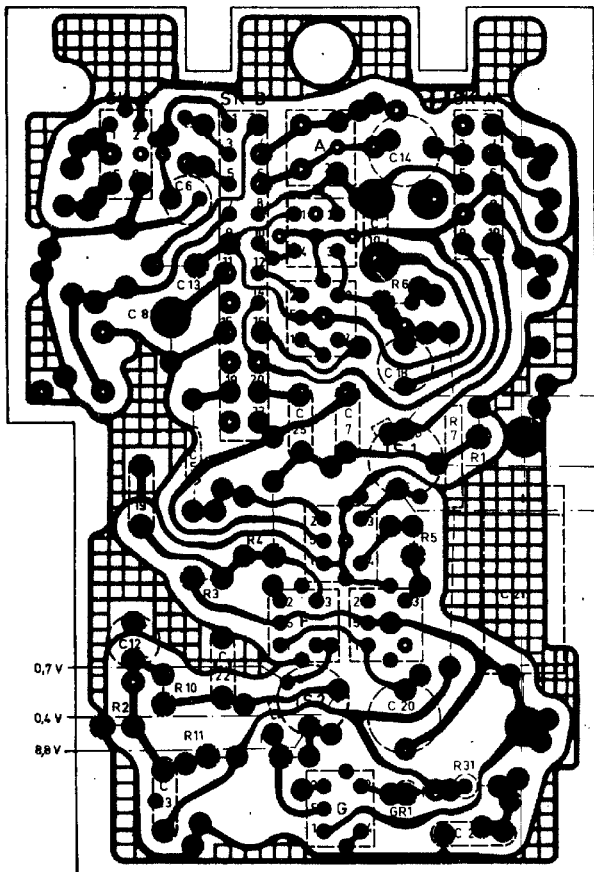

A

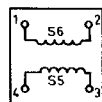

B

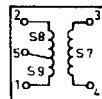

C

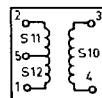

D

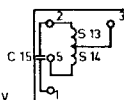

E

0,8 V

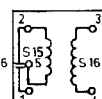

F

0,6 V

0,1 V

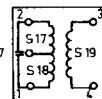

G

C 17

TS 1-2

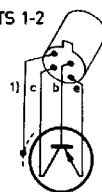

S	31, 30,
R	33,

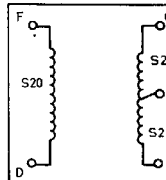
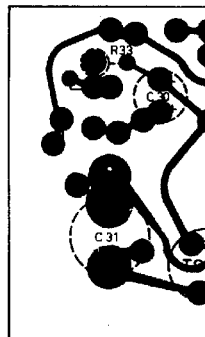

S1)	4822 179 00855	Ferrocceptor	S10)	4822 179 01046	Oscillator coil LW-MW	S20)		Driver transformer	
S2)		Ferrocceptor	S11)		Oscillatortypeel LG-MG	S21)		Ingangstransformator	
S3)		Ferrocceptor	S12)	4822 179 00856	Bob. d'oscillateur GO-PO	S22)		Transformateur de déphasage	
		Ferrocceptor		abcd	Oscillatortypeel LW-MW			Transformador de entrada	
		Ferrocceptor		1..2	Bob. de oscilador OL-OM				
S4)	4822 104 00699	Aerial series coil MW	S13)	4822 153 10169	IF band-pass filter	S23)		Output transformer	
	abcd	Antenne-seriepoel MG	S14)		MF-Bandfilterspoel	S24)		Uitgangstransformator	
	53..	Bob. d'antenne en série PO		abcd	Transformateur FI	S25)		Transformateur de sortie	
		Antennen-Seriepoel MW		71.2	ZF-Bandfilterspoel			Ausgangstransformator	
		Bob. de antena en serie OM			Transformador FI			Transformador de salida	
S5)	4822 156 40337	Aerial coil MW	S15)	4822 153 10168	IF band-pass filter	S28)		Loudspeaker	
S6)	abcd	Antennespoel MG	S16)	abcd	MF-Bandfilterspoel			Luidspreker	
	02..2	Bob. d'antenne PO		81.2	Transformateur FI			Haut-parleur	
		Antennenspoel MW			ZF-Bandfilterspoel			Lautsprecher	
		Bob. de antena OM			Transformador FI			Altavoz	
S7)	4822 156 30186	Aerial coil LW	S17)	4822 153 10171	Detector coil			Variable capacitor	
S8)	abcd	Antennespoel LG	S18)	abcd	Detectorspoel	C1)		Veriebbels condensator	
S9)	12..2	Bob. d'antenne GO	S19)	91.2	Bob. détectrice	C2)	49 002 42	Condensateur variable	
		Antennenspoel LW			Detectortypeel			Dreikondensator	
		Bob. de antena OL			Bob. detector			Condensador variable	
C5	4822 069 00819	C13		C23	4822 069 01063	C12	4822 069 00578	C33	909/U200
C6	4822 069 00574	C14		C25	4822 069 01097	C18	909/Z5	C34	909/U16
C7	4822 069 01087	C19		C26	4822 069 01065	C21	909/U400		
C8	907/50E-200E	C20		C32	4822 069 01105	C30	909/X4	R30	4822 179 01048
C11	4822 132 10044	C22		C35	4822 069 01105	C31	4822 069 00669	R32	901/W2E2

Cabinet (version -/00L, -/00R)	4822 420 40112	Coffret (version -/00L, -/00R) Ausführung	4822 420 40112	Caja (versión -/00L, -/00R)
Cabinet (version -/00S)	4822 420 40111	Coffret (version -/00S) Das Gehäuse (-/00S-Ausf.)	4822 420 40111	Caja (versión -/00S)
Rear panel (version -/00L)	4822 421 40012	Paroi arrière (version -/00L) Die Rückwand (-/00L-Ausf.)	4822 421 40012	Panel posterior (versión -/00L)
Rear panel (version -/00R)	4822 421 40011	Paroi arrière (version -/00R) Die Rückwand (-/00R-Ausf.)	4822 421 40011	Panel posterior (versión -/00R)
Rear panel (version -/00S)	4822 421 40013	Paroi arrière (version -/00S) Die Rückwand (-/00S-Ausf.)	4822 421 40013	Panel posterior (versión -/00S)
Screw to secure rear panel	4822 502 10634	Vis fix, paroi arrière	4822 502 10634	Tornillo para fij. panel posterior
Grip	4822 498 40187	Poignée	4822 498 40187	Asa
Screw to secure grip	4822 179 01025	Vis fix, poignée	4822 179 01025	Tornillo para fij. asa
Battery holder in rear panel	4822 256 60119	Porte-pile dans paroi arrière	4822 256 60119	Soporte de batería en panel posterior
Battery holder in cabinet	4822 179 01027	Porte-pile dans coffret	4822 179 01027	Soporte de batería en caja
Aerial connection	4822 179 01056	Connexion d'antenne	4822 179 01056	Conexión de antena
Earphone connection	4822 211 00965	Connexion casque d'écoute	4822 211 00965	Conexión de auricular
Nut to secure earphone connection	A3 715 60	Ecrou fix. connexion casque	A3 715 60	Tuerca para fij. conexión de auricular
Drum on variable capacitor	FK 340 18	Tambour sur cond. var.	FK 340 18	Tambor sobre cond. var.
Pointer	4822 450 80125	Aligulle	4822 450 80125	Aguja
Dial (version -/00L)	4822 334 50045	Quadrant (version -/00L) Skala (-/00L-Anzeige)	4822 334 50045	Cuadrante (versión -/00L)
Dial (version -/00R, -/00S)	4822 334 50046	Quadrant (version -/00R, -/00S) Skala (-/00R, -/00S-Anzeige)	4822 334 50046	Cuadrante (versión -/00R, -/00S)
Push button unit (on-off)	4822 276 20063	Bloc à touches (marche-arrêt) Druckstasteinheit (An-Aus)	4822 276 20063	Unidad de tecla (interruptor)
Push button (red)	4822 410 20426	Touche (rouge) Drucktaste (rot)	4822 410 20426	Tecla (rojo)
Slide switch (on-off)	4822 277 30336	Comm. coulissant (marche-arrêt) Schiebeschalter (An-Aus)	4822 277 30336	Interruptor de corredora
Slide of switch (on-off)	4822 278 20214	Tiroir du comm. (marche-arrêt) Schieber des Schalters (An-Aus)	4822 278 20214	Corredora para interruptor
Push button unit (aerial MW-LW)	4822 276 20064	Bloc à touches (antenne, PO-GO) Druckstasteinheit (MG-LG, Antenne)	4822 276 20064	Unidad de tecla (antena OM-OL)
Push button (black)	4822 410 20427	Touche (noire) Drucktaste (schwarz)	4822 410 20427	Tecla (negro)
Slide switch (MW-LW)	4822 277 30286	Comm. coulissant (PO-GO) Schiebeschalter (MW-LW)	4822 277 30286	Comm. de corredora (OM-OL)
Slide of switch (MW-LW)	4822 278 20215	Tiroir du comm. (PO-GO) Schieber des Schalters (MW-LW)	4822 278 20215	Corredora para comm. (OM-OL)
Slide switch (aerial)	4822 277 30297	Comm. coulissant (antenne) Schiebeschalter (Antenne)	4822 277 30297	Comm. de corredora (antena)
Slide of switch (aerial)	4822 278 20216	Tiroir du comm. (antenne) Schieber des Schalters (Antenne)	4822 278 20216	Corredora para comunicador (antena)
Knob (tuning)	4822 413 10041	Knopf-einstimmung	4822 413 10041	Botón-sintonización
Knob (volume)	4822 413 50498	Bouton-volume	4822 413 50498	Botón-volumen
		Knopf-Lautstärkeregelung		



# L3F42T

11. 12.	10. 13. 14.	15.	16.	17. 18.	19.	20.	21. 22.	25. 26. 23. 24. 27.
24.	15.	20. 16.	19.	22. 17.	12. 23.	26.	30. 31.	35. 34. 21. 32. 33.
5.	4.	3.	2.	9. 10.	11.	7. 31.	30. 32.	33. 36. 37. 6. 41. 34.
								40. 38. 35. 39.

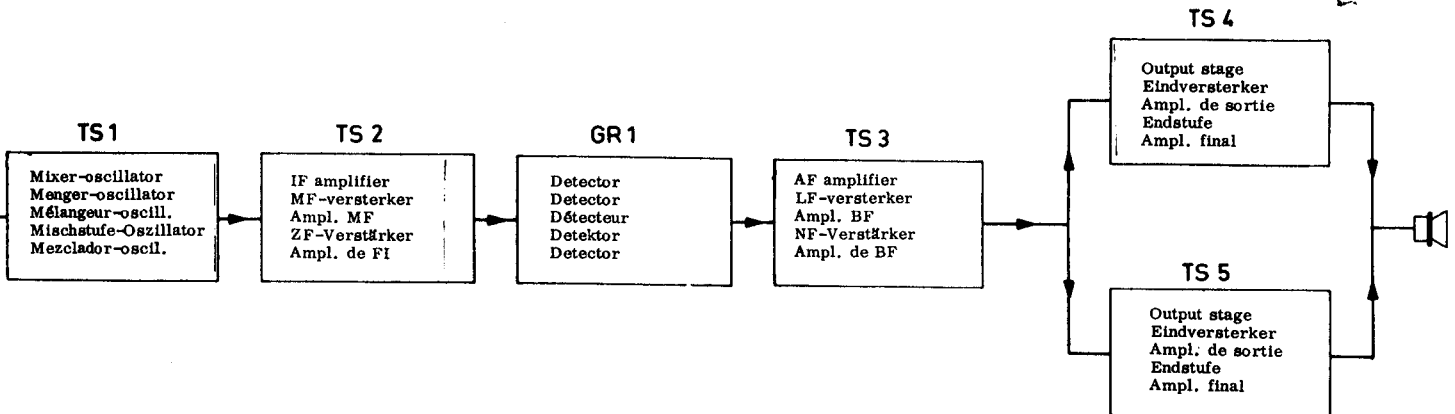
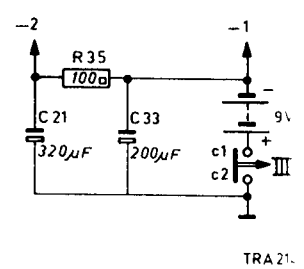
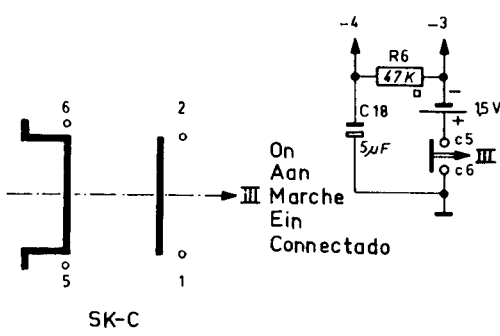
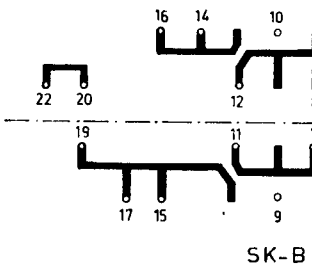
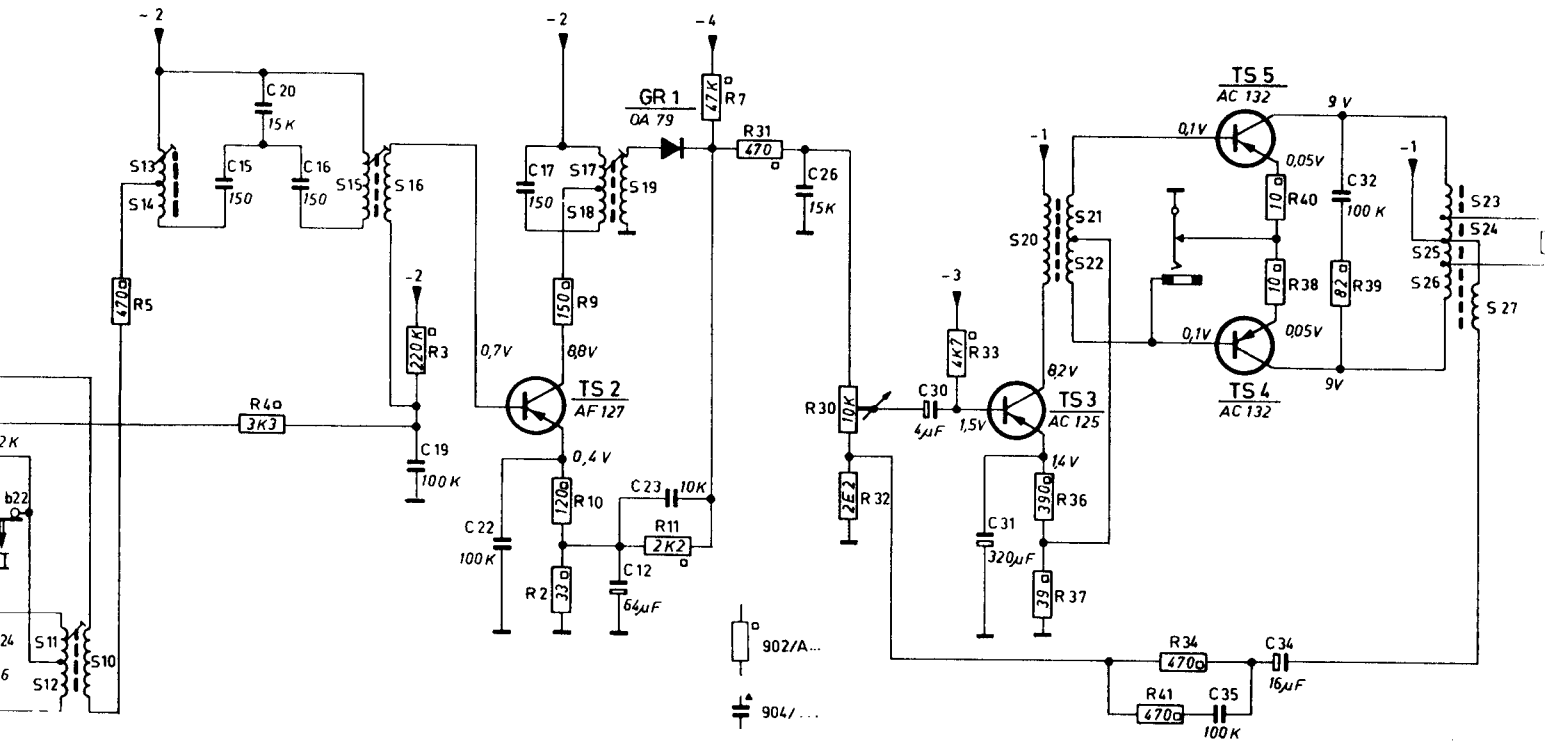



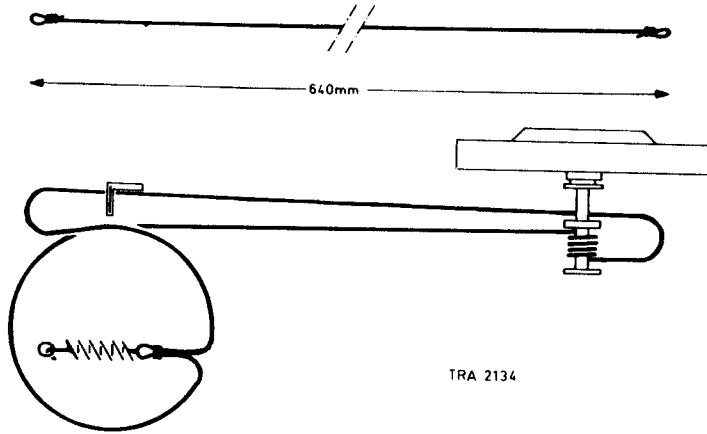

S												
C		34,	32,	35,				33,	30,	31		
R		34,	39,	40,	38,		41,	37,	36,	35,	32,	33.

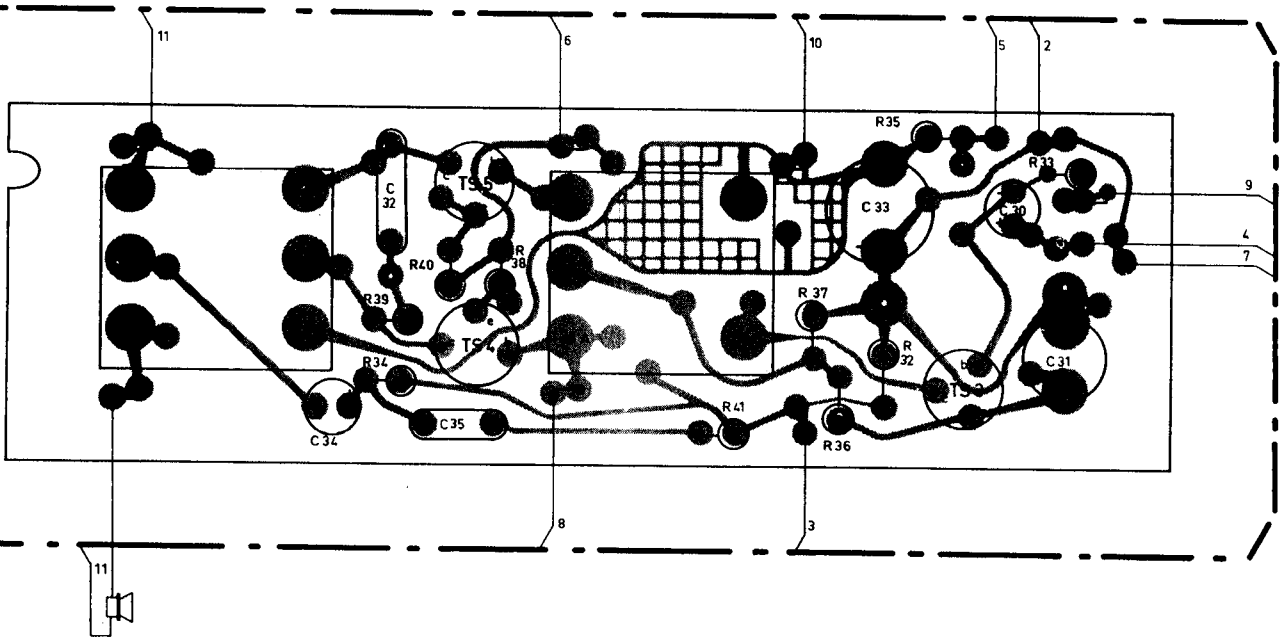

S	E,GDCBAF											
C	11	21, 26,	18, 20, 14, 10, 7, 25,	22, 5, 13, 6, 8, 23, 19, 12,								
R	30	1, 31, 7,	5, 6,	9, 4,	11, 3,	10, 2,						

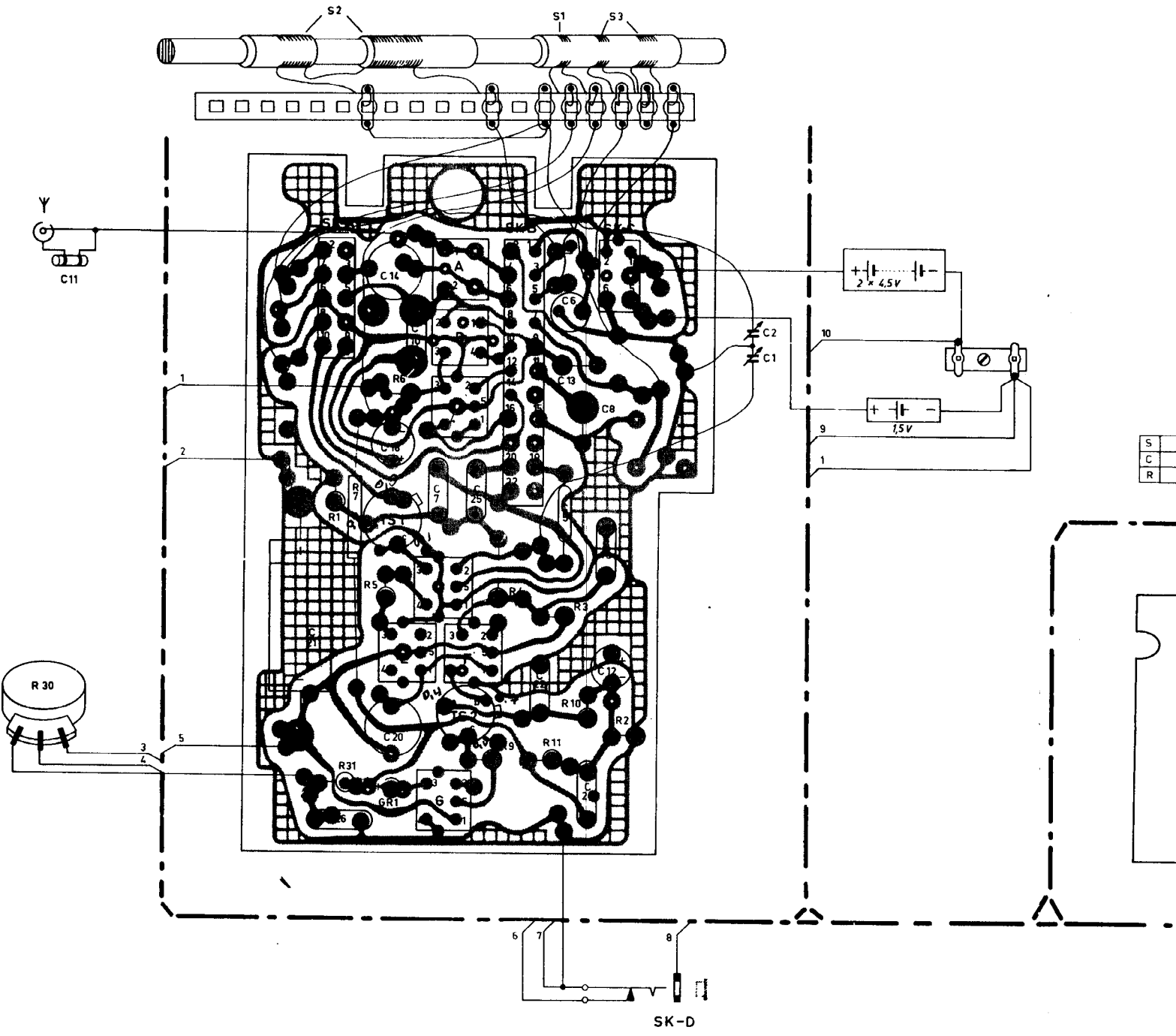

S	
C	
R	